



SPECIFICATIONS

CUSTOMER	:	PTC
SAMPLE CODE	:	PS320240T-009-I-02
MASS PRODUCTION CODE	:	PH320240T-009-I-Q
SAMPLE VERSION	:	02
SPECIFICATIONS EDITION	:	008
DRAWING NO. (Ver.)	:	LMD-PH320240T-009-I-Q_002
PACKAGING NO. (Ver.)	:	PKG-PH320240T-009-I-Q_001

Customer Approved

Date:

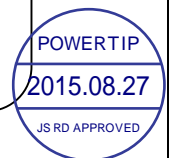

Approved	Checked	Designer
閔偉	張久慧	譚超敏

- Preliminary specification for design input
- Specification for sample approval

POWERTIP TECH. CORP.

Headquarters:

No.8, 6th Road, Taichung Industrial Park,
Taichung, Taiwan
台中市 407 工業區六路 8 號

TEL: 886-4-2355-8168
FAX: 886-4-2355-8166

E-mail: sales@powertip.com.tw
[Http://www.powertip.com.tw](http://www.powertip.com.tw)

History of Version

Date (mm / dd / yyyy)	Ver.	Edi.	Description	Page	Design by
05/07/2007	-	0	MASS PRODUCTION	-	Peter
06/22/2007	-	A	Modify B/L Connector number	-	Peter
08/18/2008	01	001	1.Modify Average Brightness. 2.Modify Power Dissipation of B/L 3. Modify Backlight Tolerances.	6 9 Appendix	Jared
02/03/2009	01	002	Modify LCD V.A. dim	Appendix	Timter
12/16/2010	01	003	Modify 1.5 Optical Characteristics Modify 3.2. Inspection Specification Modify 4. RELIABILITY TEST Modify 5. PRECAUTION RELATING PRODUCT HANDLING	6 19 26 27	Timter
04/07/2014	01	004	Modify Viewing Angle & Contrast Ratio	6	劉進
04/19/2014	01	005	Modify Optical Characteristics Modify Backlight Characteristics	6 9	劉進
05/08/2014	01	006	Modify The Unit Of Forward Voltage	9	劉進
11/07/2014	02	007	Change the BL	6,9	譚超敏
08/24/2015	02	008	Show Backlight Life Time	9	譚超敏

Total : 27 Page

Contents

1. SPECIFICATIONS

- 1.1 Features
- 1.2 Mechanical Specifications
- 1.3 Absolute Maximum Ratings
- 1.4 DC Electrical Characteristics
- 1.5 Optical Characteristics
- 1.6 Backlight Characteristics

2. MODULE STRUCTURE

- 2.1 Counter Drawing
- 2.2 Interface Pin Description
- 2.3 Timing Characteristics
- 2.4 JUMPER(Setting different use)

3. QUALITY ASSURANCE SYSTEM

- 3.1 Quality Assurance Flow Chart
- 3.2 Inspection Specification

4. RELIABILITY TEST

- 4.1 Reliability Test Condition

5. PRECAUTION RELATING PRODUCT HANDLING

- 5.1 Safety
- 5.2 Handling
- 5.3 Storage
- 5.4 Terms of Warranty

Appendix : LCM Drawing
Packaging

Note : For detailed information please refer to IC data sheet :
Primacy(TFT LCD): Himax: HX8218-A + HX8615A(Or compatible IC)

1. SPECIFICATIONS

1.1 Features

Main LCD panel

Item	Standard Value
Display Type	320(R · G · B) * 240 Dots
LCD Type	Normally white, Transmissive type
Screen size (inch)	5.7 inch
Viewing Direction	6 O'clock
Color configuration	RGB-Strip
Interface	Digital 24-bits RGB
Other (controller/driver IC)	320(R · G · B) * 240 Dots
ROHS	THIS PRODUCT CONFORMS THE ROHS OF PTC Detail information please refer web site : http://www.powertip.com.tw/news.php?area_id_view=1085560481/

1.2 Mechanical Specifications

Item	Standard Value	Unit
Outline Dimension	159.4 (W) * 111.0 (L) * 9.0 (H)	mm

LCD panel

Item	Standard Value	Unit
Viewing Area	116.2 (W) * 87.4 (L)	mm
Active Area	115.2 (W) * 86.4 (L)	mm

Note : For detailed information please refer to LCM drawing

1.3 Absolute Maximum Ratings

Module

Item	Symbol	Condition	Min.	Max.	Unit
System Power Supply Voltage	VDD	VSS=0	-0.3	7.0	V
Input Voltage	V _i	-	-0.3	VDD+0.3	V
Operating Temperature	T _{OP}	-	-20	70	°C
Storage Temperature	T _{ST}	-	-30	80	°C

1.4 DC Electrical Characteristics

Module

GND = 0V, T_a = 25°C

Item	Symbol	Condition	Min.	Typ.	Max.	Unit
Power Supply Voltage1	VDD	-	3.0	3.3	3.6	V
Supply Current	IDD	VDD = 3.3 V Pattern=full display	-	90	-	mA
		VDD = 3.3 V Pattern= black *1	-	95	140	mA

Note1 : Maximum current display

1.5 Optical Characteristics

TFT LCD Module

VDD= 3.3V, Ta=25°C

Item		Symbol	Condition	Min.	Typ.	Max.	Unit	-
Response time	Rise	Tr	-	-	15	30	ms	Note 2
	Fall	Tf		-	35	50		
Viewing angle	Top	$\theta Y+$	CR \geq 10	-	60	-	Deg.	Note 4
	Bottom	$\theta Y-$		-	60	-		
	Left	$\theta X-$		-	60	-		
	Right	$\theta X+$		-	60	-		
Contrast ratio		CR	-	500	600	-	-	Note 3
Color of CIE Coordinate (With B/L)	White	X	IF=200mA	0.26	0.31	0.36	-	Note1
		Y		0.28	0.33	0.38		
	Red	X		0.57	0.62	0.67		
		Y		0.32	0.37	0.42		
	Green	X		0.27	0.32	0.37		
		Y		0.56	0.61	0.66		
	Blue	X		0.09	0.14	0.19		
		Y		0.03	0.08	0.13		
Average Brightness Pattern=white display (With B/L)		IV	IF=200mA	470	550	-	cd/m ²	Note1
Uniformity (With B/L)		ΔB	IF=200mA	70	-	-	%	Note1

Note 1:

*1 : $\Delta B = B(\text{min}) / B(\text{max}) * 100\%$

*2 : Measurement Condition for Optical Characteristics:

a : Environment: $25^{\circ}\text{C} \pm 5^{\circ}\text{C}$ / $60 \pm 20\% \text{R.H}$, no wind , dark room below 10 Lux at typical lamp current and typical operating frequency.

b : Measurement Distance: 500 ± 50 mm , ($\theta = 0^{\circ}$)

c : Equipment: TOPCON BM-7 fast , (field 1°) , after 10 minutes operation.

d : The uncertainty of the C.I.E coordinate measurement ± 0.01 , Average Brightness $\pm 4\%$

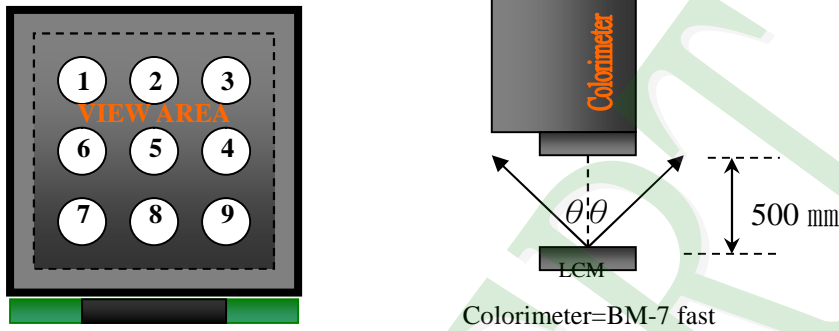

To be measured at the center area of panel with a viewing cone of 1° by Topcon luminance meter BM-7, after 10 minutes operation (module)

Note2: Definition of response time:

The output signals of photo detector are measured when the input signals are changed from "black" to "white"(falling time) and from "white" to "black"(rising time), respectively. The response time is defined as the time interval between the 10% and 90% of Amplitudes.

Refer to figure as below:

Normally White



Normally Black

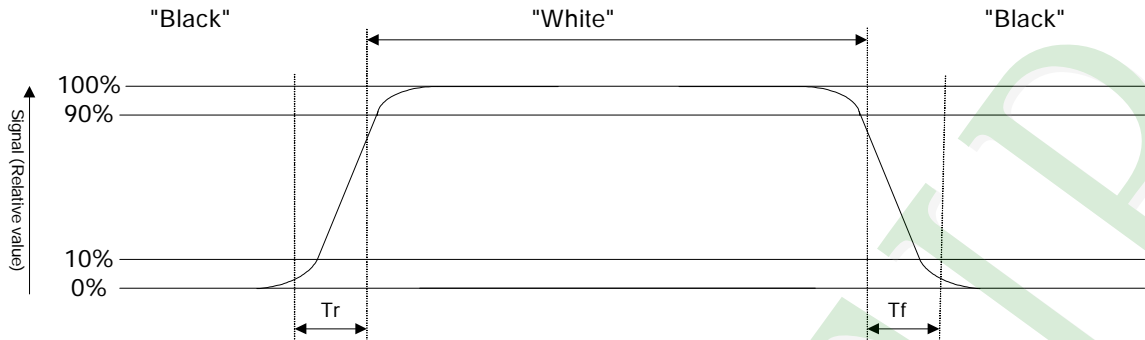

Note3: Definition of contrast ratio:

Contrast ratio is calculated with the following formula

$$\text{Contrast ratio (CR)} = \frac{\text{Photo detector output when LCD is at "White" state}}{\text{Photo detector output when LCD is at "Black" state}}$$

Note4: Definition of viewing angle:

Refer to figure as below:

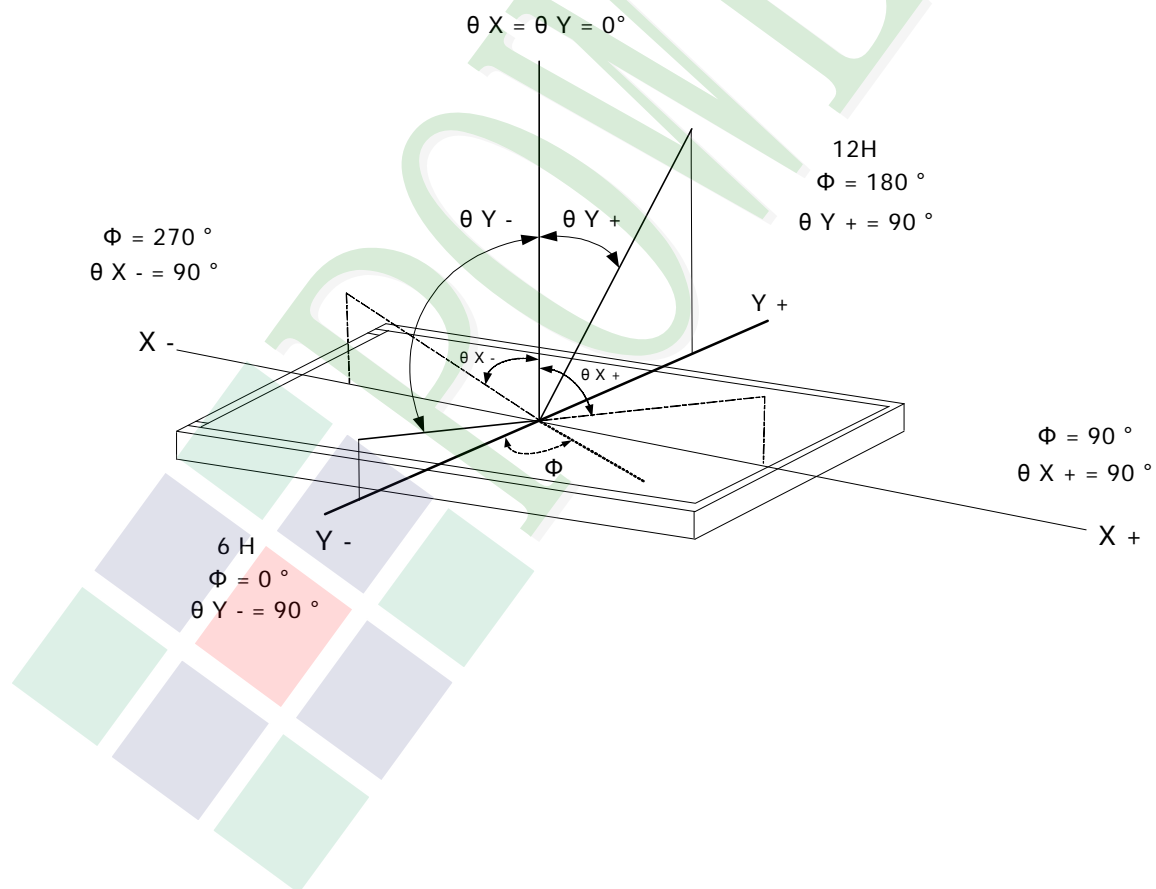

1.6 Backlight Characteristics

Maximum Ratings

Item	Symbol	Conditions	Min.	Max.	Unit
LED Power Dissipation	PD _{LED}	Ta =25°C / 20mA	-	0.12	W
Power Dissipation	PD	Ta =25°C	-	2.4	W

Electrical / Optical Characteristics

Item	Symbol	Conditions	Min.	Typ.	Max.	Unit
Forward Voltage	VF	IF = 200 mA	5.7	6.5	7.5	V
Average Brightness (Without LCD)	IV		7650	8800	9950	cd/m ²
CIE Color Coordinate (Without LCD)	X		0.26	0.29	0.32	-
	Y		0.26	0.29	0.32	
Color	White					

Internal Circuit Diagram

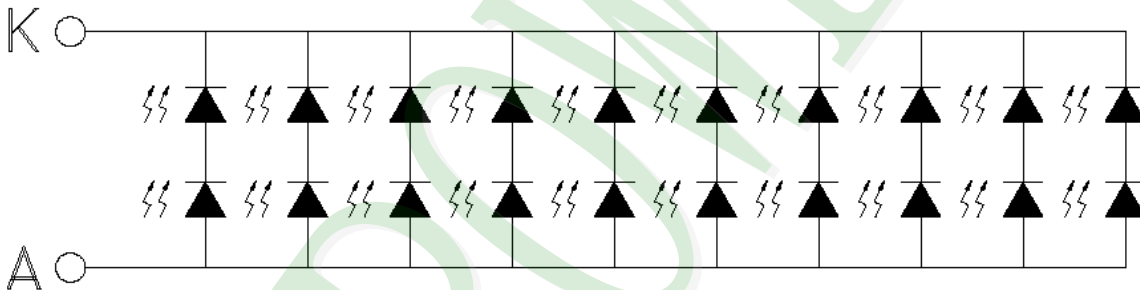

Other Description

Item	Conditions	Description
Life Time	Ta =25°C IF= 200mA	50000 hrs

2. MODULE STRUCTURE

2.1 Counter Drawing

2.1.1 LCM Mechanical Diagram

* See Appendix

2.1.2 Block Diagram

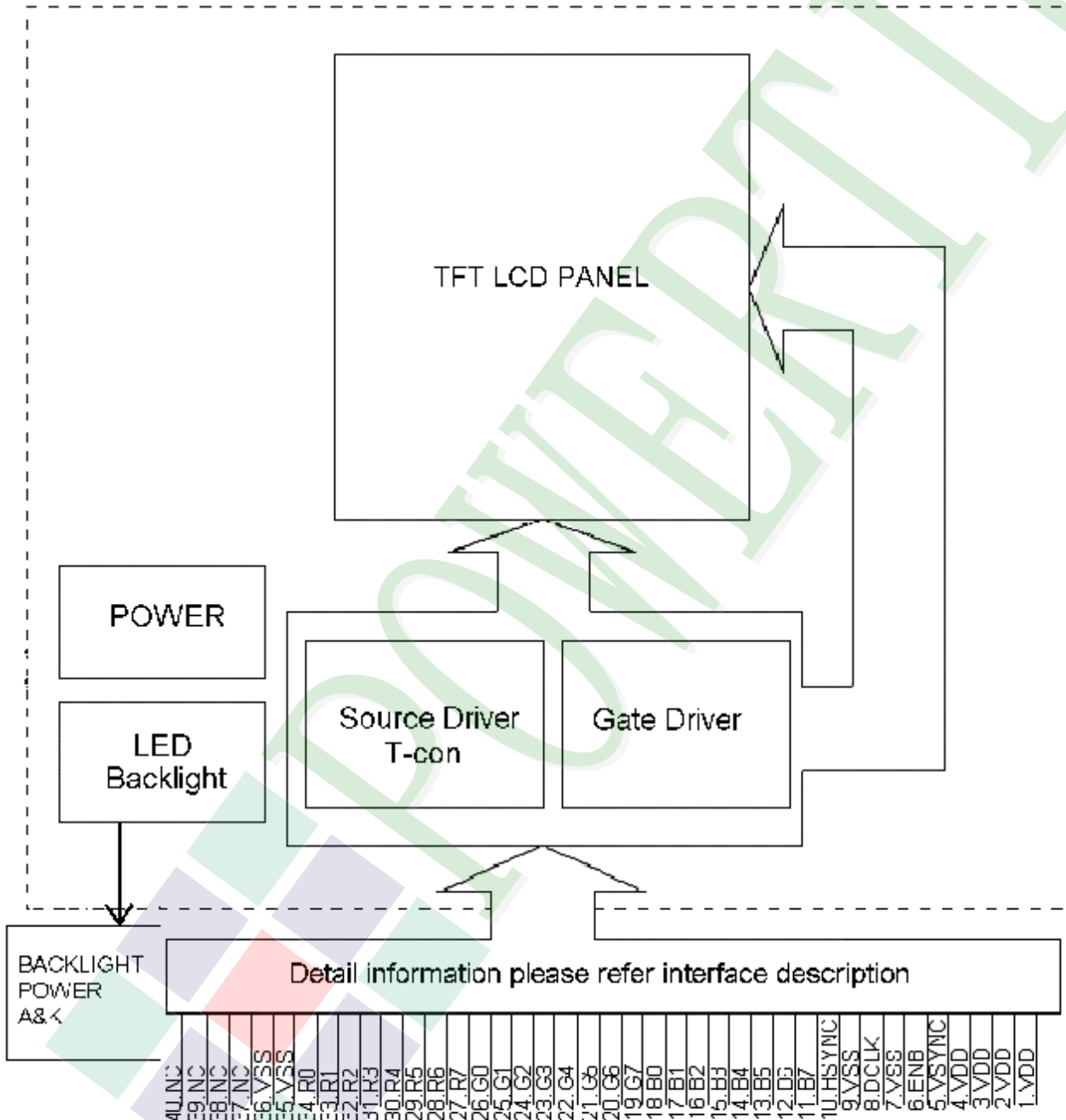

2.2 Interface Pin Description

Pin No.	Symbol	Function
1	VDD	Analog power.
2	VDD	
3	VDD	
4	VDD	
5	VSYNC	Vertical sync input
6	ENB	Data enable control
7	VSS	Ground
8	DCLK	Dot data clock
9	VSS	Ground
10	HSYNC	Horizontal sync input
11	B7	data bit B7
12	B6	data bit B6
13	B5	data bit B5
14	B4	data bit B4
15	B3	data bit B3
16	B2	data bit B2
17	B1	data bit B1
18	B0	data bit B0
19	G7	data bit G7
20	G6	data bit G6
21	G5	data bit G5
22	G4	data bit G4
23	G3	data bit G3
24	G2	data bit G2
25	G1	data bit G1
26	G0	data bit G0

Interface Pin Description(CONT.)

27	R7	data bit R7
28	R6	data bit R6
29	R5	data bit R5
30	R4	data bit R4
31	R3	data bit R3
32	R2	data bit R2
33	R1	data bit R1
34	R0	data bit R0
35	VSS	Ground
36	VSS	Ground
37	NC	No use.
38	NC	No use.
39	NC	No use.
40	NC	No use.

Backlight Pin Description

1	A	Power supply for LED Backlight anode input.
2	NC	No use.
3	K	Power supply for LED Backlight cathode input.

2.3 Timing Characteristics

Signal	Item	Symbol	Min.	Typ.	Max.	Unit	
Dclk	Frequency	Dclk		6.4		MHz	
	High Time	Tch		78		ns	
	Low Time	Tcl		78		ns	
Data	Setup Time	Tds	12			ns	
	Hold Time	Tdh	12			ns	
Hsync	Period	TH		408		DCLK	
	Pulse Width	Thp		30		DCLK	
	Back-Porch	Thb		38		DCLK	
	Display Period	Thd		320		DCLK	
	Front-Porch	Thf		20		DCLK	
Vsync	Period	NTSC	Tv	262.5		TH	
		PAL		312.5			
	Pulse Width		Tvp	1	3	5	TH
	Back-Porch	NTSC	Tvb	15		TH	
		PAL		23			
	Display Period		Tvd		240		TH
	Front-Porch	NTSC	Tvf	4.5		TH	
		PAL		46.5			

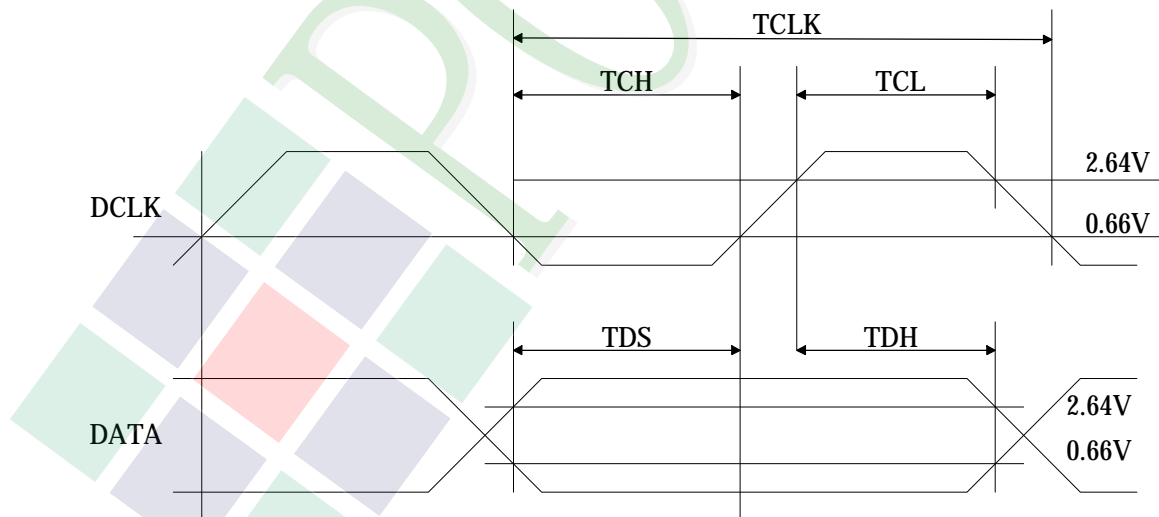

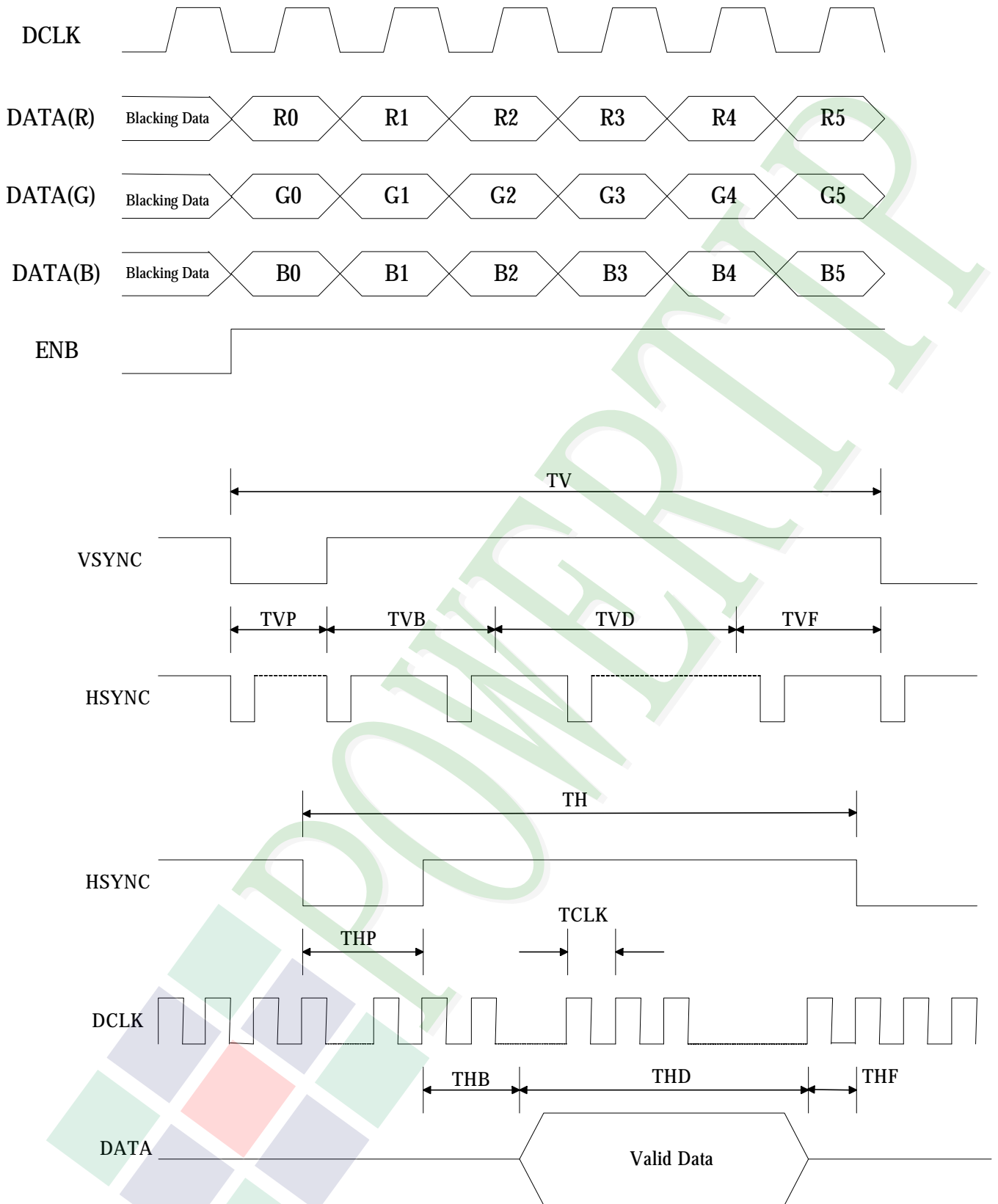

Color Data Assignment

COLOR	INPUT DATA	R DATA								G DATA								B DATA							
		R7	R6	R5	R4	R3	R2	R1	R0	G7	G6	G5	G4	G3	G2	G1	G0	B7	B6	B5	B4	B3	B2	B1	B0
		MSB							LSB	MSB							LSB	MSB							LSB
BASIC COLOR	BLACK	0	0	0	0	0	0	0	0	0	0	0	0	0	0	0	0	0	0	0	0	0	0	0	0
	RED(255)	1	1	1	1	1	1	1	1	0	0	0	0	0	0	0	0	0	0	0	0	0	0	0	
	GREEN(255)	0	0	0	0	0	0	0	0	1	1	1	1	1	1	1	0	0	0	0	0	0	0	0	
	BLUE(255)	0	0	0	0	0	0	0	0	0	0	0	0	0	0	0	1	1	1	1	1	1	1	1	
	CYAN	0	0	0	0	0	0	0	0	1	1	1	1	1	1	1	1	1	1	1	1	1	1	1	
	MAGENTA	1	1	1	1	1	1	1	1	0	0	0	0	0	0	0	1	1	1	1	1	1	1	1	
	YELLOW	1	1	1	1	1	1	1	1	1	1	1	1	1	1	1	0	0	0	0	0	0	0	0	
	WHITE	1	1	1	1	1	1	1	1	1	1	1	1	1	1	1	1	1	1	1	1	1	1	1	
RED	RED(0)	0	0	0	0	0	0	0	0	0	0	0	0	0	0	0	0	0	0	0	0	0	0		
	RED(1)	0	0	0	0	0	0	1	0	0	0	0	0	0	0	0	0	0	0	0	0	0	0		
	RED(2)	0	0	0	0	0	0	1	0	0	0	0	0	0	0	0	0	0	0	0	0	0	0	0	
	RED(254)	1	1	1	1	1	1	1	0	0	0	0	0	0	0	0	0	0	0	0	0	0	0	0	
	RED(255)	1	1	1	1	1	1	1	1	0	0	0	0	0	0	0	0	0	0	0	0	0	0	0	
GREEN	GREEN(0)	0	0	0	0	0	0	0	0	0	0	0	0	0	0	0	0	0	0	0	0	0	0		
	GREEN(1)	0	0	0	0	0	0	0	0	0	0	0	0	0	1	0	0	0	0	0	0	0	0		
	GREEN(2)	0	0	0	0	0	0	0	0	0	0	0	0	0	1	0	0	0	0	0	0	0	0		
	GREEN(254)	0	0	0	0	0	0	0	1	1	1	1	1	1	0	0	0	0	0	0	0	0	0		
GREEN(255)	0	0	0	0	0	0	0	1	1	1	1	1	1	1	0	0	0	0	0	0	0	0			
BLUE	BLUE(0)	0	0	0	0	0	0	0	0	0	0	0	0	0	0	0	0	0	0	0	0	0	0		
	BLUE(1)	0	0	0	0	0	0	0	0	0	0	0	0	0	0	0	0	0	0	0	0	0	1		
	BLUE(2)	0	0	0	0	0	0	0	0	0	0	0	0	0	0	0	0	0	0	0	0	1	0		
	BLUE(254)	0	0	0	0	0	0	0	0	0	0	0	0	0	0	1	1	1	1	1	1	1	0		
BLUE(255)	0	0	0	0	0	0	0	0	0	0	0	0	0	0	1	1	1	1	1	1	1	1			

[Note]

- (1) Definition of gray scale
Color (n) : n means level of gray scale
Larger n means brighter level
- (2) Data: 1-High, 0-Low

2.4 JUMPER(Setting different use)

J1-1J2-2,J3-2,J4-1,J5-1,J6-2

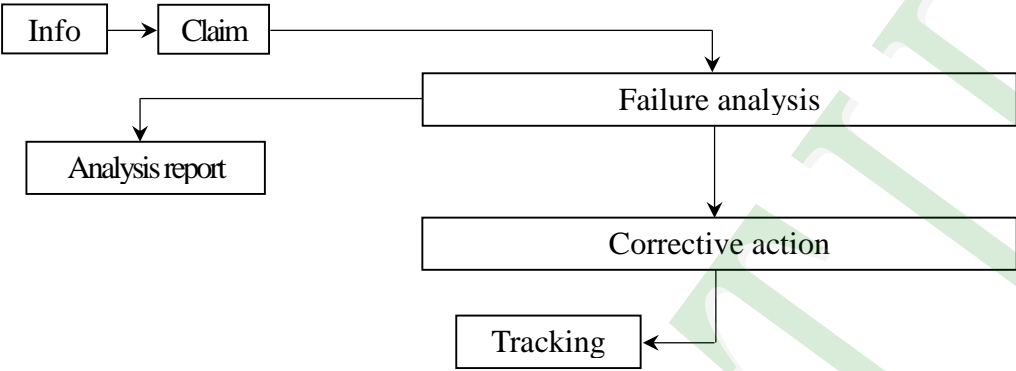

Item	Customer	Sales	R&D	Q.A	Manufacturing	Product control	Purchase	Inventory control
Sales Service	 <pre> graph TD Info[Info] --> Claim[Claim] Claim --> Failure[Failure analysis] Failure --> Report[Analysis report] Failure --> Action[Corrective action] Action --> Tracking[Tracking] </pre>							
Q.A Activity	1. ISO 9001 Maintenance Activities 3. Equipment calibration 5. Standardization Management				2. Process improvement proposal 4. Education And Training Activities			

3.2. Inspection Specification

- ◆Scope : The document shall be applied to TFT-LCD Module for 3.5" ~10" (Ver.B01).
- ◆Inspection Standard : MIL-STD-105E Table Normal Inspection Single Sampling Level II.
- ◆Equipment : Gauge 、 MIL-STD 、 Powertip Tester 、 Sample
- ◆Defect Level : Major Defect AQL : 0.4 ; Minor Defect AQL : 1.5
- ◆OUT Going Defect Level : Sampling.
- ◆Standard of the product appearance test :

a. Manner of appearance test :

- (1). The test best be under 20W×2 fluorescent light , and distance of view must be at 30 cm.
- (2). The test direction is base on about around 45° of vertical line.

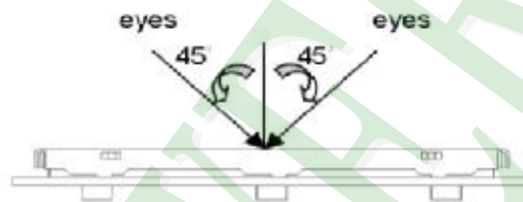

(3). Definition of area.

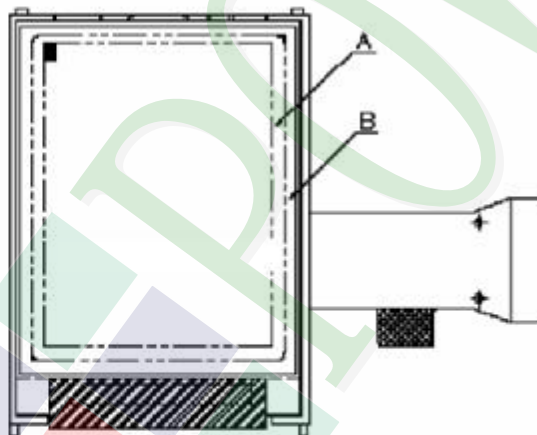

A area : viewing area

B area : Outside of viewing area

(4). Standard of inspection : (Unit : mm)



◆ Specification For TFT-LCD Module 3.5" ~ 10" :

(Ver.B01)

NO	Item	Criterion	Level										
01	Product condition	1. 1 The part number is inconsistent with work order of production.	Major										
		1. 2 Mixed product types.	Major										
		1. 3 Assembled in inverse direction.	Major										
02	Quantity	2. 1 The quantity is inconsistent with work order of production.	Major										
03	Outline dimension	3. 1 Product dimension and structure must conform to structure diagram.	Major										
		4. 1 Missing line character and icon.	Major										
04	Electrical Testing	4. 2 No function or no display.	Major										
		4. 3 Display malfunction.	Major										
		4. 4 LCD viewing angle defect.	Major										
		4. 5 Current consumption exceeds product specifications.	Major										
05	Dot defect (Bright dot , Dark dot) On -display	<table border="1"> <thead> <tr> <th>Item</th> <th>Acceptance (Q'ty)</th> </tr> </thead> <tbody> <tr> <td>Bright Dot</td> <td>≤ 4</td> </tr> <tr> <td>Dark Dot</td> <td>≤ 5</td> </tr> <tr> <td>Joint Dot</td> <td>≤ 3</td> </tr> <tr> <td>Total</td> <td>≤ 7</td> </tr> </tbody> </table>	Item	Acceptance (Q'ty)	Bright Dot	≤ 4	Dark Dot	≤ 5	Joint Dot	≤ 3	Total	≤ 7	Minor
		Item	Acceptance (Q'ty)										
		Bright Dot	≤ 4										
		Dark Dot	≤ 5										
		Joint Dot	≤ 3										
Total	≤ 7												
5. 1 Inspection pattern : full white , full black , Red , Green and blue screens.													
5. 2 It is defined as dot defect if defect area $> 1/2$ dot.													
5. 3 The distance between two dot defect ≥ 5 mm.													

◆ Specification For TFT-LCD Module 3.5" ~10" :

(Ver.B01)

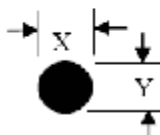
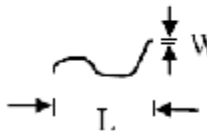
NO	Item	Criterion	Level																						
06	Black or white dot、scratch、contamination Round type  $\Phi = (x + y) / 2$ Line type 	6.1 Round type (Non-display or display) : <table border="1"> <thead> <tr> <th rowspan="2">Dimension (diameter : Φ)</th> <th colspan="2">Acceptance (Q'ty)</th> </tr> <tr> <th>A area</th> <th>B area</th> </tr> </thead> <tbody> <tr> <td>$\Phi \leq 0.25$</td> <td colspan="2">Ignore</td> </tr> <tr> <td>$0.25 < \Phi \leq 0.50$</td> <td>5</td> <td rowspan="2">Ignore</td> </tr> <tr> <td>$\Phi > 0.50$</td> <td>0</td> </tr> <tr> <td>Total</td> <td colspan="2">5</td> </tr> </tbody> </table>	Dimension (diameter : Φ)	Acceptance (Q'ty)		A area	B area	$\Phi \leq 0.25$	Ignore		$0.25 < \Phi \leq 0.50$	5	Ignore	$\Phi > 0.50$	0	Total	5		Minor						
		Dimension (diameter : Φ)		Acceptance (Q'ty)																					
A area	B area																								
$\Phi \leq 0.25$	Ignore																								
$0.25 < \Phi \leq 0.50$	5	Ignore																							
$\Phi > 0.50$	0																								
Total	5																								
6.2 Line type(Non-display or display) : <table border="1"> <thead> <tr> <th rowspan="2">Length (L)</th> <th rowspan="2">Width (W)</th> <th colspan="2">Acceptance (Q'ty)</th> </tr> <tr> <th>A area</th> <th>B area</th> </tr> </thead> <tbody> <tr> <td>---</td> <td>$W \leq 0.03$</td> <td colspan="2">Ignore</td> </tr> <tr> <td>$L \leq 10.0$</td> <td>$0.03 < W \leq 0.05$</td> <td>4</td> <td rowspan="2">Ignore</td> </tr> <tr> <td>$L \leq 5.0$</td> <td>$0.05 < W \leq 0.10$</td> <td>2</td> </tr> <tr> <td>---</td> <td>$W > 0.10$</td> <td colspan="2">As round type</td> </tr> <tr> <td>Total</td> <td colspan="2">5</td> <td></td> </tr> </tbody> </table>	Length (L)	Width (W)	Acceptance (Q'ty)		A area	B area	---	$W \leq 0.03$	Ignore		$L \leq 10.0$	$0.03 < W \leq 0.05$	4	Ignore	$L \leq 5.0$	$0.05 < W \leq 0.10$	2	---	$W > 0.10$	As round type		Total	5		
Length (L)			Width (W)	Acceptance (Q'ty)																					
	A area	B area																							
---	$W \leq 0.03$	Ignore																							
$L \leq 10.0$	$0.03 < W \leq 0.05$	4	Ignore																						
$L \leq 5.0$	$0.05 < W \leq 0.10$	2																							
---	$W > 0.10$	As round type																							
Total	5																								
07	Polarizer Bubble	<table border="1"> <thead> <tr> <th rowspan="2">Dimension (diameter : Φ)</th> <th colspan="2">Acceptance (Q'ty)</th> </tr> <tr> <th>A area</th> <th>B area</th> </tr> </thead> <tbody> <tr> <td>$\Phi \leq 0.25$</td> <td colspan="2">Ignore</td> </tr> <tr> <td>$0.25 < \Phi \leq 0.50$</td> <td>4</td> <td rowspan="2">Ignore</td> </tr> <tr> <td>$0.50 < \Phi \leq 0.80$</td> <td>1</td> </tr> <tr> <td>$\Phi > 0.80$</td> <td>0</td> <td></td> </tr> <tr> <td>Total</td> <td colspan="2">5</td> </tr> </tbody> </table>	Dimension (diameter : Φ)	Acceptance (Q'ty)		A area	B area	$\Phi \leq 0.25$	Ignore		$0.25 < \Phi \leq 0.50$	4	Ignore	$0.50 < \Phi \leq 0.80$	1	$\Phi > 0.80$	0		Total	5		Minor			
Dimension (diameter : Φ)	Acceptance (Q'ty)																								
	A area	B area																							
$\Phi \leq 0.25$	Ignore																								
$0.25 < \Phi \leq 0.50$	4	Ignore																							
$0.50 < \Phi \leq 0.80$	1																								
$\Phi > 0.80$	0																								
Total	5																								

◆Specification For TFT-LCD Module 3.5" ~10" :

(Ver.B01)

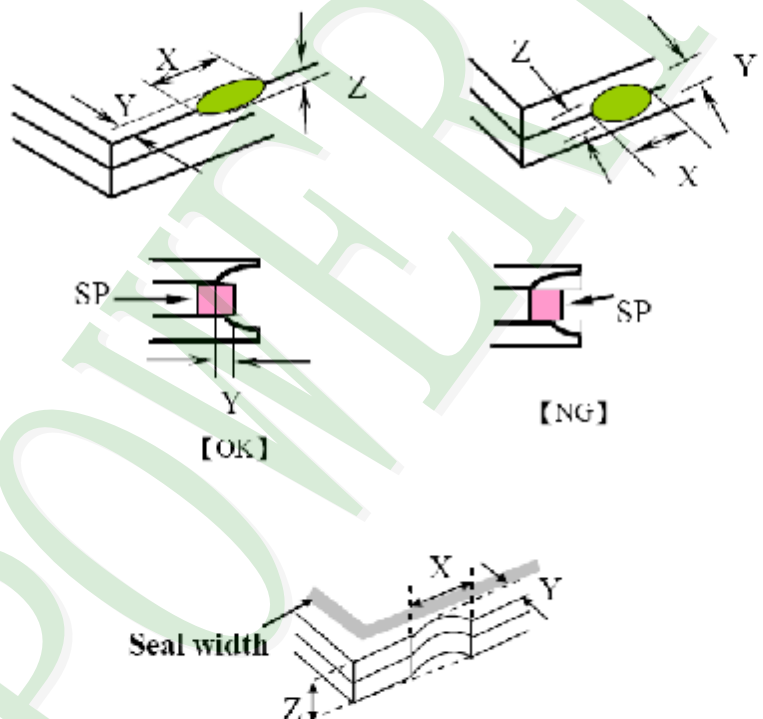
NO	Item	Criterion	Level						
08	The crack of glass	<p>Symbols :</p> <p>X : The length of crack Z : The thickness of crack t : The thickness of glass</p> <p>Y : The width of crack. W : terminal length a : LCD side length</p>	Minor						
		<p>8.1 General glass chip :</p> <p>8.1.1 Chip on panel surface and crack between panels:</p>  <table border="1" data-bbox="542 1568 1340 1859"> <tr> <td style="text-align: center;">X</td> <td style="text-align: center;">Y</td> <td style="text-align: center;">Z</td> </tr> <tr> <td style="text-align: center;">$\leq a$</td> <td style="text-align: center;">Crack can't enter viewing area</td> <td style="text-align: center;">$\leq 1/2 t$</td> </tr> <tr> <td style="text-align: center;">$\leq a$</td> <td style="text-align: center;">Crack can't exceed the half of SP width.</td> <td style="text-align: center;">$1/2 t < Z \leq 2 t$</td> </tr> </table>		X	Y	Z	$\leq a$	Crack can't enter viewing area	$\leq 1/2 t$
X	Y	Z							
$\leq a$	Crack can't enter viewing area	$\leq 1/2 t$							
$\leq a$	Crack can't exceed the half of SP width.	$1/2 t < Z \leq 2 t$							

◆ Specification For TFT-LCD Module 3.5" ~10" :

(Ver.B01)

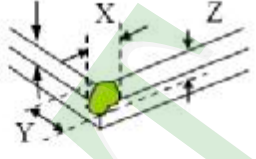
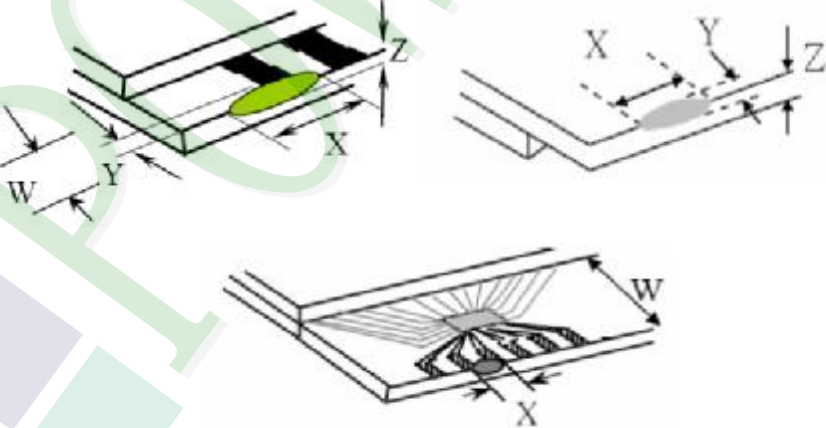
NO	Item	Criterion	Level												
08	The crack of glass	<p>Symbols :</p> <p>X : The length of crack Z : The thickness of crack t : The thickness of glass</p> <p>Y : The width of crack. W : terminal length a : LCD side length</p> <hr/> <p>8.1.2 Corner crack :</p>  <table border="1" data-bbox="523 772 1332 1064"> <thead> <tr> <th>X</th> <th>Y</th> <th>Z</th> </tr> </thead> <tbody> <tr> <td>$\leq 1/5 a$</td> <td>Crack can't enter viewing area</td> <td>$Z \leq 1/2 t$</td> </tr> <tr> <td>$\leq 1/5 a$</td> <td>Crack can't exceed the half of SP width.</td> <td>$1/2 t < Z \leq 2 t$</td> </tr> </tbody> </table>	X	Y	Z	$\leq 1/5 a$	Crack can't enter viewing area	$Z \leq 1/2 t$	$\leq 1/5 a$	Crack can't exceed the half of SP width.	$1/2 t < Z \leq 2 t$				
		X	Y	Z											
$\leq 1/5 a$	Crack can't enter viewing area	$Z \leq 1/2 t$													
$\leq 1/5 a$	Crack can't exceed the half of SP width.	$1/2 t < Z \leq 2 t$													
		<p>8.2 Protrusion over terminal :</p> <p>8.2.1 Chip on electrode pad :</p>  <table border="1" data-bbox="561 1691 1343 1863"> <thead> <tr> <th></th> <th>X</th> <th>Y</th> <th>Z</th> </tr> </thead> <tbody> <tr> <td>Front</td> <td>$\leq a$</td> <td>$\leq 1/2 W$</td> <td>$\leq t$</td> </tr> <tr> <td>Back</td> <td>$\leq a$</td> <td>$\leq W$</td> <td>$\leq 1/2 t$</td> </tr> </tbody> </table>		X	Y	Z	Front	$\leq a$	$\leq 1/2 W$	$\leq t$	Back	$\leq a$	$\leq W$	$\leq 1/2 t$	Minor
	X	Y	Z												
Front	$\leq a$	$\leq 1/2 W$	$\leq t$												
Back	$\leq a$	$\leq W$	$\leq 1/2 t$												

◆ Specification For TFT-LCD Module 3.5" -10" :

(Ver.B01)

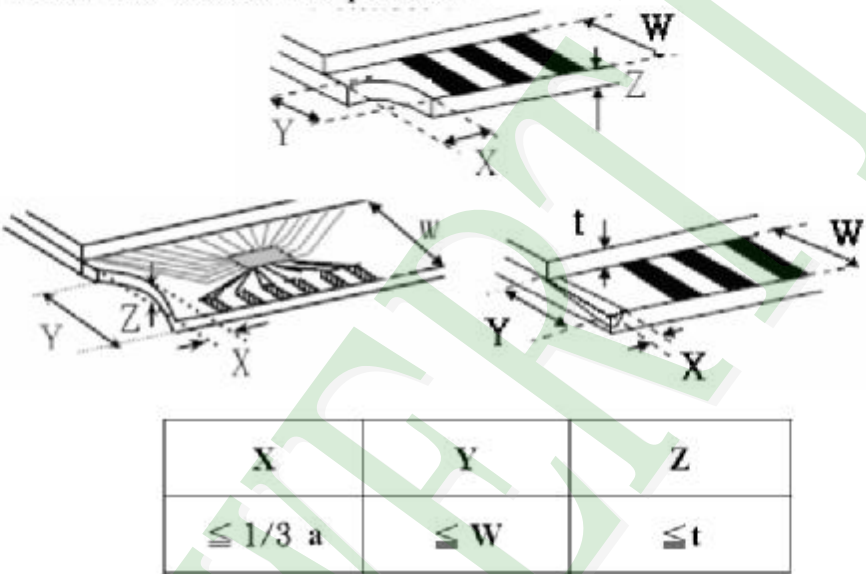
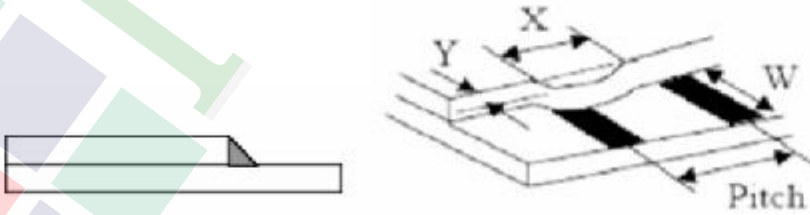
NO	Item	Criterion	Level									
08	The crack of glass	Symbols : X : The length of crack Z : The thickness of crack t : The thickness of glass Y : The width of crack. W : terminal length a : LCD side length	Minor									
		8.2.2 Non-conductive portion :  <p style="text-align: center;"> <table border="1" style="margin-left: auto; margin-right: auto;"> <tr> <td style="padding: 5px;">X</td> <td style="padding: 5px;">Y</td> <td style="padding: 5px;">Z</td> </tr> <tr> <td style="padding: 5px;">$\leq 1/3 a$</td> <td style="padding: 5px;">$\leq W$</td> <td style="padding: 5px;">$\leq t$</td> </tr> </table> </p> <p>⊙ If the chipped area touches the ITO terminal, over 2/3 of the ITO must remain and be inspected according to electrode terminal specifications.</p> 8.2.3 Glass remain :  <p style="text-align: center;"> <table border="1" style="margin-left: auto; margin-right: auto;"> <tr> <td style="padding: 5px;">X</td> <td style="padding: 5px;">Y</td> <td style="padding: 5px;">Z</td> </tr> <tr> <td style="padding: 5px;">$\leq a$</td> <td style="padding: 5px;">$\leq 1/3 W$</td> <td style="padding: 5px;">$\leq t$</td> </tr> </table> </p>		X	Y	Z	$\leq 1/3 a$	$\leq W$	$\leq t$	X	Y	Z
X	Y	Z										
$\leq 1/3 a$	$\leq W$	$\leq t$										
X	Y	Z										
$\leq a$	$\leq 1/3 W$	$\leq t$										



◆Specification For TFT-LCD Module 3.5" ~10" :

(Ver.B01)

NO	Item	Criterion	Level
09	Backlight elements	9. 1 Backlight can't work normally.	Major
		9. 2 Backlight doesn't light or color is wrong.	Major
		9. 3 Illumination source flickers when lit.	Major
10	General appearance	10. 1 Pin type 、 quantity 、 dimension must match type in structure diagram.	Major
		10. 2 No short circuits in components on PCB or FPC .	Major
		10. 3 Parts on PCB or FPC must be the same as on the production characteristic chart .There should be no wrong parts , missing parts or excess parts.	Major
		10. 4 Product packaging must the same as specified on packaging specification sheet.	Minor
		10. 5 The folding and pceled off in polarizer are not acceptable.	Minor
		10. 6 The PCB or FPC between B/L assembled distance(PCB or FPC) is ≤ 1.5 mm.	Minor

5. PRECAUTION RELATING PRODUCT HANDLING

5.1 SAFETY

- 5.1.1 If the LCD panel breaks , be careful not to get the liquid crystal to touch your skin.
- 5.1.2 If the liquid crystal touches your skin or clothes , please wash it off immediately by using soap and water.

5.2 HANDLING

- 5.2.1 Avoid any strong mechanical shock which can break the glass.
- 5.2.2 Avoid static electricity which can damage the CMOS LSI—When working with the module , be sure to ground your body and any electrical equipment you may be using.
- 5.2.3 Do not remove the panel or frame from the module.
- 5.2.4 The polarizing plate of the display is very fragile. So , please handle it very carefully ,do not touch , push or rub the exposed polarizing with anything harder than an HB pencil lead (glass , tweezers , etc.)
- 5.2.5 Do not wipe the polarizing plate with a dry cloth , as it may easily scratch the surface of plate.
- 5.2.6 Do not touch the display area with bare hands , this will stain the display area.
- 5.2.7 Do not use ketonics solvent & aromatic solvent. Use with a soft cloth soaked with a cleaning naphtha solvent.
- 5.2.8 To control temperature and time of soldering is $320\pm 10^{\circ}\text{C}$ and 3-5 sec.
- 5.2.9 To avoid liquid (include organic solvent) stained on LCM .

5.3 STORAGE

- 5.3.1 Store the panel or module in a dark place where the temperature is $25^{\circ}\text{C} \pm 5^{\circ}\text{C}$ and the humidity is below 65% RH.
- 5.3.2 Do not place the module near organics solvents or corrosive gases.
- 5.3.3 Do not crush , shake , or jolt the module.

5.4 TERMS OF WARRANTY

- 5.4.1 Applicable warrant period
The period is within thirteen months since the date of shipping out under normal using and storage conditions.
- 5.4.2 Unaccepted responsibility
This product has been manufactured to your company's specification as a part for use in your company's general electronic products. It is guaranteed to perform according to delivery specifications. For any other use apart from general electronic equipment , we cannot take responsibility if the product is used in nuclear power control equipment , aerospace equipment , fire and security systems or any other applications in which there is a direct risk to human life and where extremely high levels of reliability are required.

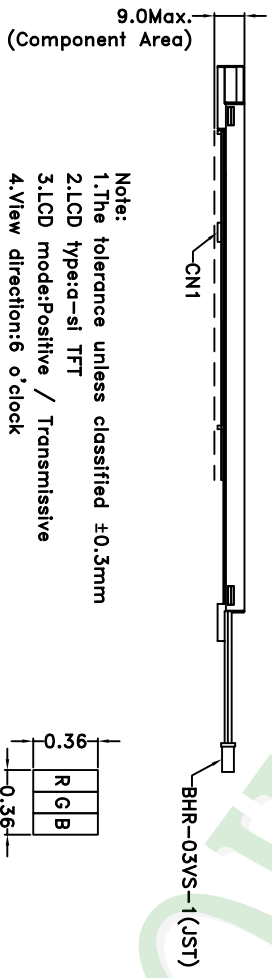
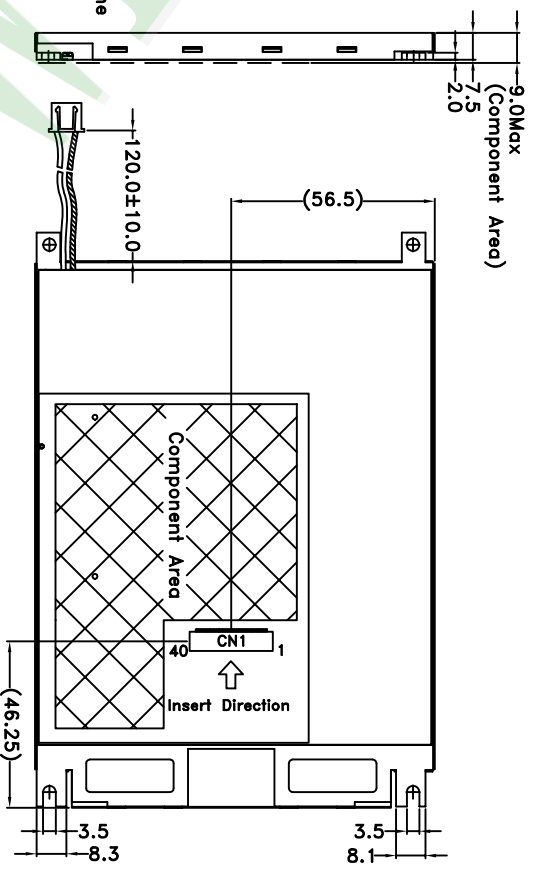
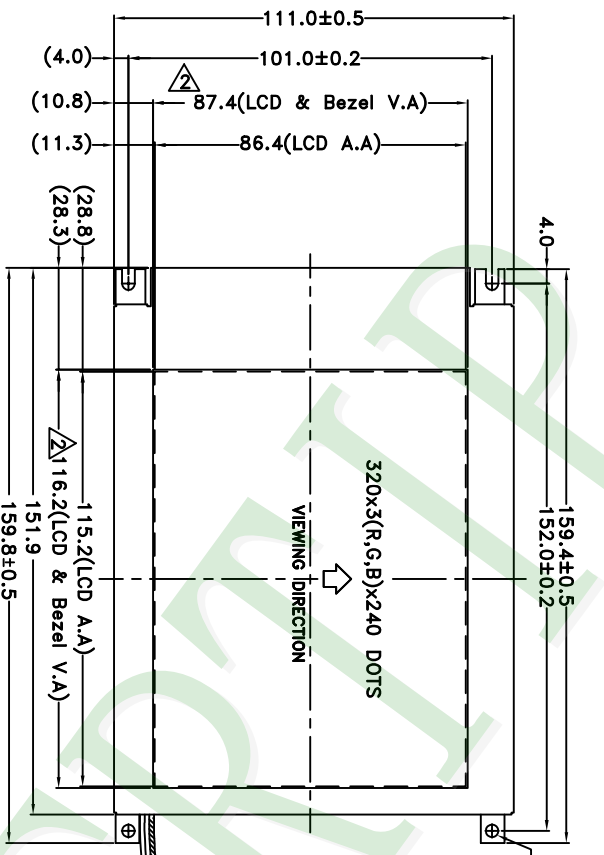

- Note:
1. The tolerance unless classified ±0.3mm
 2. LCD type: a-si TFT
 3. LCD mode: Positive / Transmissive
 4. View direction: 6 o'clock
 5. T_{op} = -20° C ~ 70° C, T_{st} = -30° C ~ 80° C
 6. α = (P0.5x39 = 19.5±0.05, W = 0.3±0.03)
 7. CN1: 9681S-40A-GF (RISO)
 8. PCB Component Area

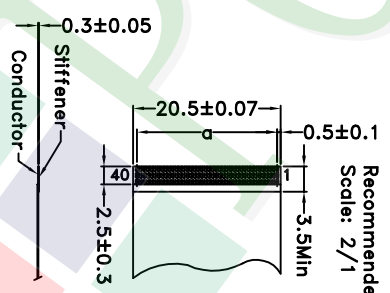
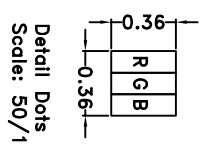

REV	0	NEW DRAWING	REV BY	REVISER	DATE	PART NO.:	PH320240T-009-I-Q	DRAWING NAME:	LMD-PH320240T-009-I-Q	Design	Mag	Unit	MM	Material	Surface	Thickness	Quantity	Precision Level
REV	A	Modify B/L Connector number	Mag	Mag	2007/06/21	TITLE:	LCD MODULE DRAWING	Check	Stone	Check	Stone	Scale	1:2.1	Thickness	16 ~ 63	Quantity	-	-
REV	0	NEW DRAWING	Mag	Mag	2007/05/03	Design	Mag	Approve	Linda	Approve	Linda	Page	1/1	Quantity	250 ~ 1000	Quantity	-	-

久正光电股份有限公司
POWER TIP TECHNOLOGY CORPORATION

Approve	Check	Contact
Oliver	Stone	Mag

Documents NO. PKG-PH320240T-009-I-Q

1. 包裝材料規格表 (Packaging Material) : (per carton)

No.	Item	Model	Dimensions (mm)	1Pcs Weight	Quantity	Total Weight
1	成品 (LCM)	PH320240T-009-I-Q	159.4 X 111.0	0.1412	28	3.9536
2	氣泡袋(1)Bubble Bag	BAG170150BRABA	170 X 150	0.0045	28	0.126
3	A6隔板(2)A6 Partition	BX33800012BZBA	338 X 125 X 3	0.038	16	0.608
4	B6隔板(3)B6 Partition	BX29800012BZBA	298 X 125 X 3	0.023	4	0.092
5	海綿墊(4)Foam Rubber Cushion	OTFOAM00005ABA	330 X 290 X 10	0.025	4	0.1
6	舒美墊(5)EPE	OTFOAMT0006ABA	218 X 125 X 20	0.0117	4	0.0468
7	C4內盒(6)Product Box	BX36031014AABA	360 X 310 X 142	0.406	2	0.812
8	外紙箱(7)Carton	BX39432432CCBA	394 X 324 X 321	0.884	1	0.884
9						

2. 一整箱總重量 (Total LCD Weight in carton) : 6.62 Kg±10%

3. 單箱數量規格表 (Packaging Specifications and Quantity) :

(1)Quantity Of Spacer : A6隔板 X 8 , B6隔板 X 2

(2)Total LCM quantity in carton : quantity per box 14 x no of boxes 2 = 28

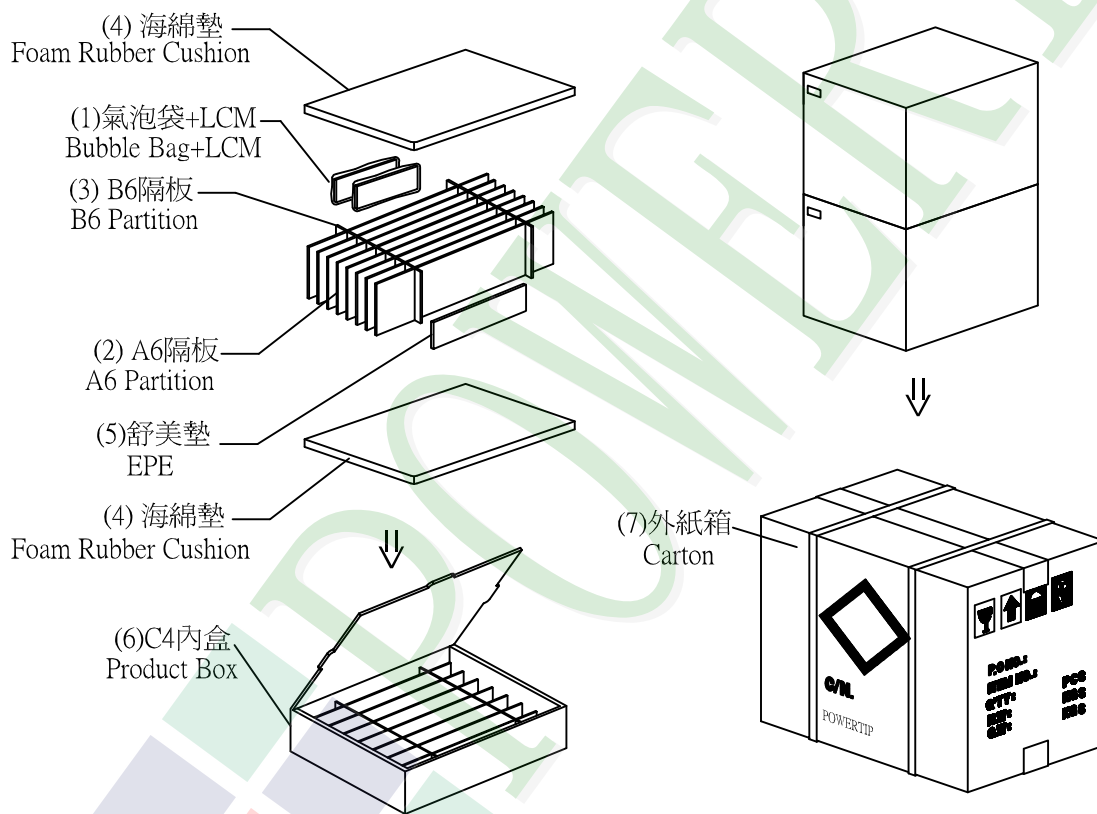

特 記 事 項 (REMARK)

1. Label Specifications :

MODEL:
LOT NO:
QUANTITY:
CHECK:

2. 每個間隔放2片模組，前後間隔不放置模組。(如示意圖)
2. 2 LCM are placed on every other slot of the divider.
Note: First and last slot should be empty.
(See remarks 3 on packaging specifications)

3. 放置格示意圖:
3. Each divider is placed inside a product Box

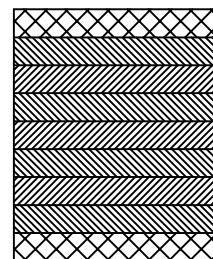

▨ 模組(LCM) X 2pcs.
▣ 舒美墊(EPE)